

Type-C

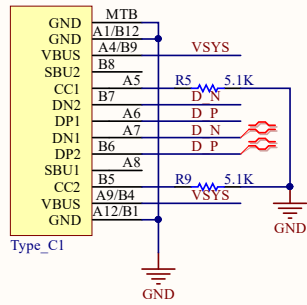

Power

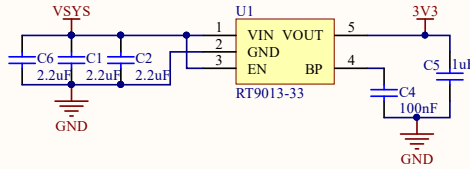

RGB

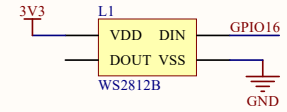

RP2040

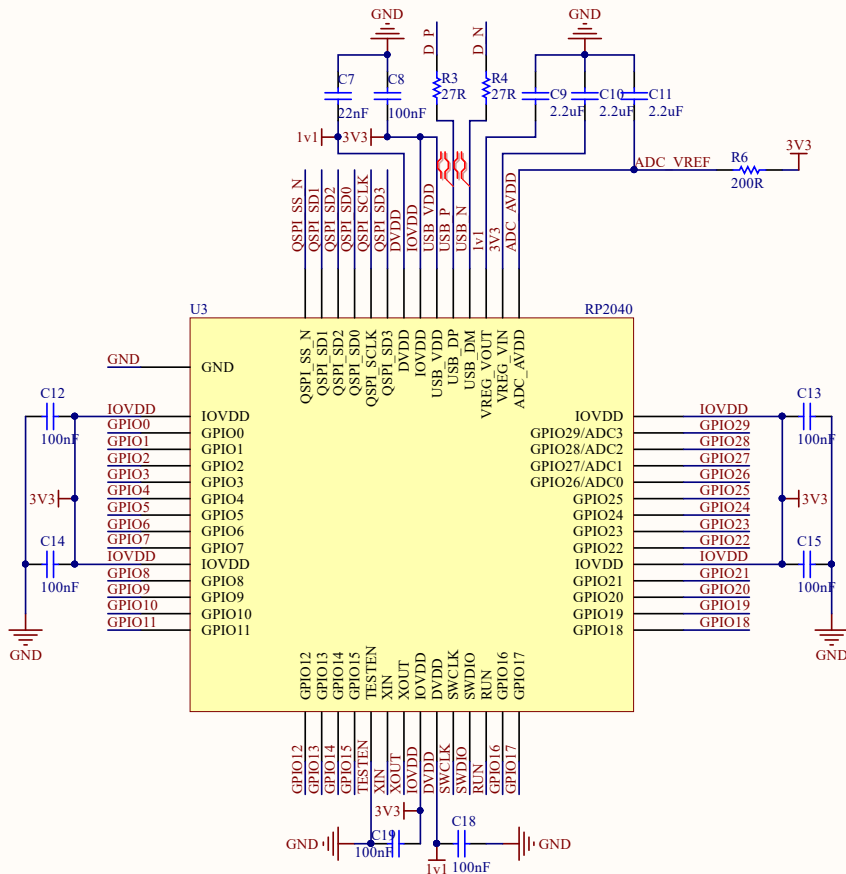

Key

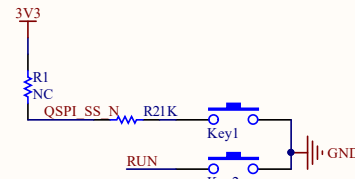

Flash

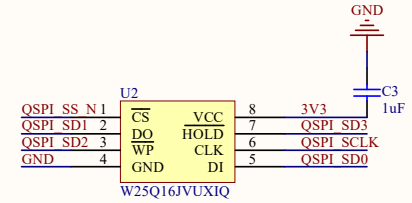

RP2040_Zero



XTAL

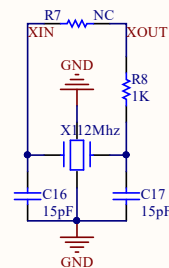

Pin Out

